

Inside. Out.



Into The Great Wide Open

WHY PANORAMIC DOORS™?

Panoramic Doors™ redefines indoor-outdoor living with a patented, hingeless design that is as innovative as it is elegant. Unlike traditional bi-fold or accordion doors, each precision-crafted panel glides, pivots, and stacks independently, offering endless configurations tailored to your space and vision. Designed and assembled in the USA with premium materials since 2010, Panoramic Doors™ combines meticulous engineering with sophistication. The bottom-weighted track allows seamless installation without costly header modifications in most cases, making it ideal for both new builds and renovations. A curated selection of finishes and hardware enables bespoke personalization, transforming residential and commercial spaces alike with clean lines, smooth movement, and an immersive connection to the surrounding landscape. More than just a door, Panoramic Doors™ blurs the boundary between indoors and out, enhancing how you experience space, light, and design.

◀ Lake Chelan, Washington, Parmenter Homes

▶ Panoramic Doors™ HQ, Fort Worth, Texas, Reggie W.



DISTINCTIVE SYSTEM OPERATION

SLIDE-PIVOT-STACK

The Panoramic Doors™ patented “Slide-Pivot-Stack” system reimagines how spaces open and flow, offering a level of flexibility unmatched by traditional wide-opening glass doors. Each individual panel glides effortlessly to the main door’s opening, pivots with precision, and stacks neatly to one or both sides. The result is a seamless transformation: walls dissolve, boundaries fade, and your space opens fully to the outdoors, creating an uninterrupted connection to light, air, and landscape.

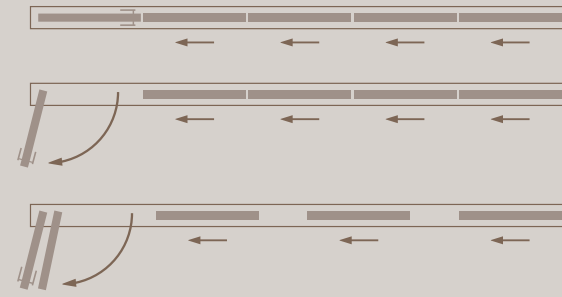

BOTTOM WEIGHTED TRACK

Panoramic Door™ panels are engineered with a bottom-weighted design, a feature that sets them apart from traditional bi-fold systems. By resting the full weight of the panels on the lower track, this innovative approach eliminates the need for costly header modifications, simplifying installation and reducing structural demands. Whether part of a new construction or a thoughtful remodel, the result is a streamlined process that delivers both form and function —effortlessly blending design elegance with practical versatility.

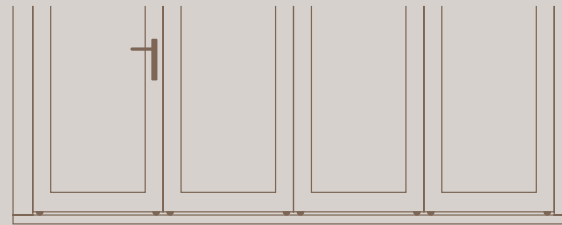

HINGELESS DESIGN

Reimagining the boundaries between indoors and out, Panoramic Doors™ patented “Slide-Pivot-Stack” system offers a revolutionary approach to wide-opening doors and windows. Each panel glides smoothly to the edge, pivots with ease, and operates independently, allowing you to customize airflow, control foot traffic, or completely open up your space. The result is a dynamic, flexible design that transforms walls into fluid connections, merging architecture and environment with effortless precision.

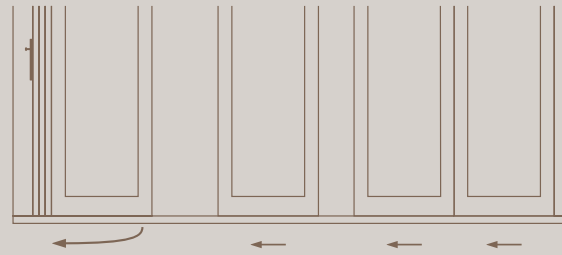

► Breaux Bridge, Louisiana, Guidry Builders





SIGNATURE ALUMINUM DOOR

The Signature Aluminum Series from Panoramic Doors™ is our best-selling system, renowned for its versatility, durability, and sleek modern design. Featuring the patented Slide-Pivot-Stack functionality, it offers superior flexibility compared to traditional bi-fold systems. Available in various colors, configurations, and an optional wood-clad finish, it effortlessly complements any design vision. Built to withstand coastal conditions with DP-50 approval, the Signature Series delivers reliable performance in storm-prone environments. Ideal for open-concept living, it creates seamless connections to the outdoors with clean lines and smooth operation, making it our most sought-after choice year after year.

KEY FEATURES

- “Slide-Pivot-Stack” patented design
- Hingeless construction
- Made in the USA
- Made to measure
- Florida Building Code approval
- Standard glass package:
Solarban 70™/clear (other options available)

◀ Saratoga, California

DOOR CONFIGURATION

The Signature Aluminum Door is available with three different main door placements. You can have your main door located on the right or left sides or opt for butterfly with main doors on both ends of the system.

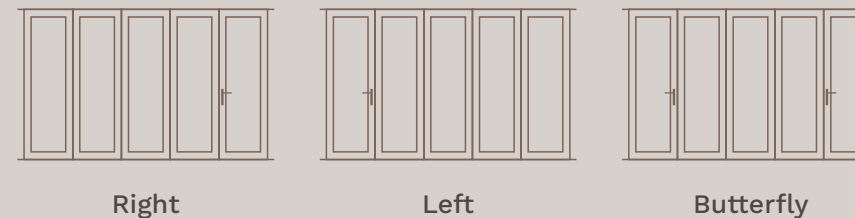

DOOR SPECIFICATIONS

Max System Width	Unlimited
Max System Height	10 ft
Max Panel Width	40 in
Main Door One End	Yes
Main Door Both Ends (Butterfly)	Yes
U-Factor	0.35
Wood U-Factor	0.34
SHGC	0.17
Florida Building Code	FL42251.1

STANDARD COLORS

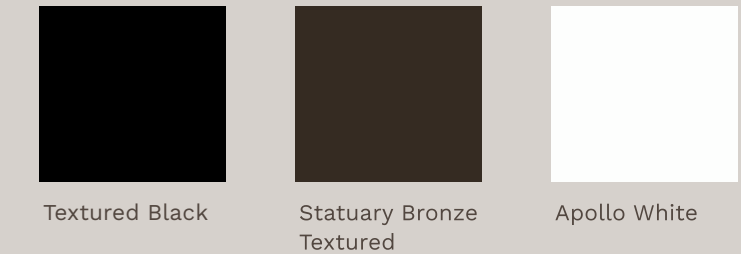

SPECIAL ORDER WOOD OPTIONS

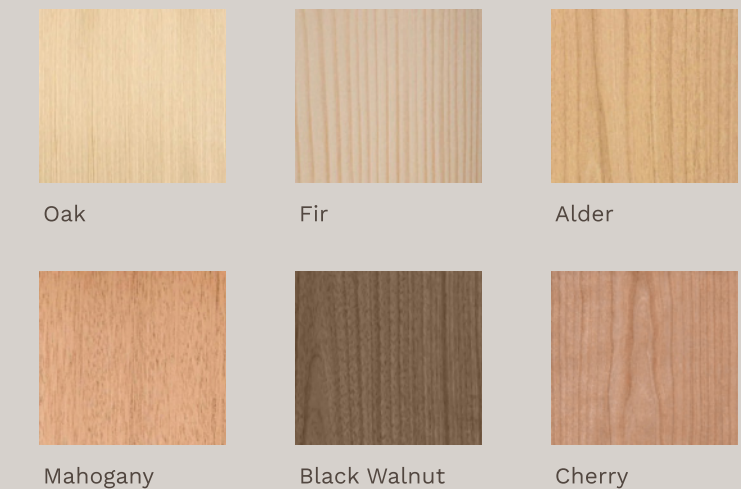

PREMIUM ORDER

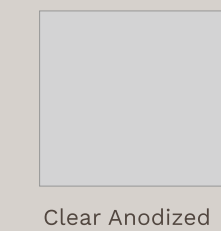

200+ RAL COLORS

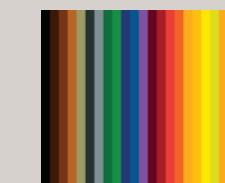

CUSTOM COLORS





CHAMBERLIN DOOR

Redefining energy efficiency and sustainability, the Chamberlin Series combines performance with modern design. With the sleek frame profile of our acclaimed Signature Series Aluminum Door, it features a foam-filled core for enhanced thermal efficiency. Paired with dual-pane glazing, it achieves top-tier energy ratings among aluminum sliding doors. Fully Title 24 compliant, it meets the highest energy standards while maintaining the clean lines and contemporary aesthetic Panoramic Doors™ is known for. The Chamberlin Series seamlessly blends superior performance, sustainability, and style.

KEY FEATURES

- Design Pressure Rating, DP 50**
- California Title 24 compliant**
- Florida Building Code approved**
- Enhanced energy efficiency with foam insulation**
- Standard glass package: LoE™ 366/i89**

◀ Los Altos Hills, California

DOOR CONFIGURATION

The Chamberlin Door is available with three different main door placements. You can have your main door located on the right or left sides or opt for butterfly with main doors on both ends of the system.

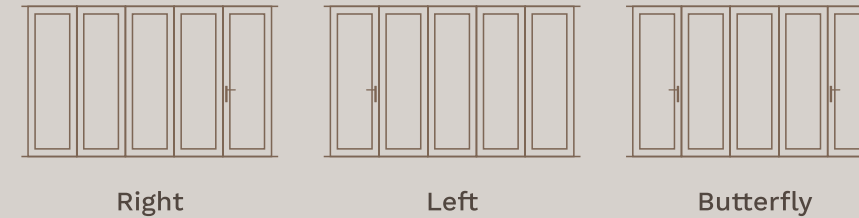

DOOR SPECIFICATIONS

Max System Width	Unlimited
Max System Height	10 ft
Max Panel Width	40 in
Main Door One End	Yes
Main Door Both Ends (Butterfly)	Yes
U-Factor	0.29
Wood U-Factor	0.27
SHGC	0.17 - 0.18
Florida Building Code	FL42298.1

STANDARD COLORS

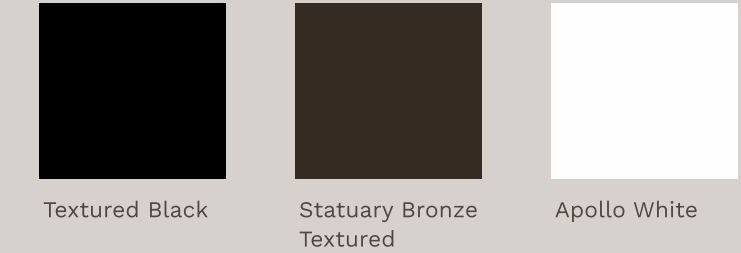

SPECIAL ORDER WOOD OPTIONS

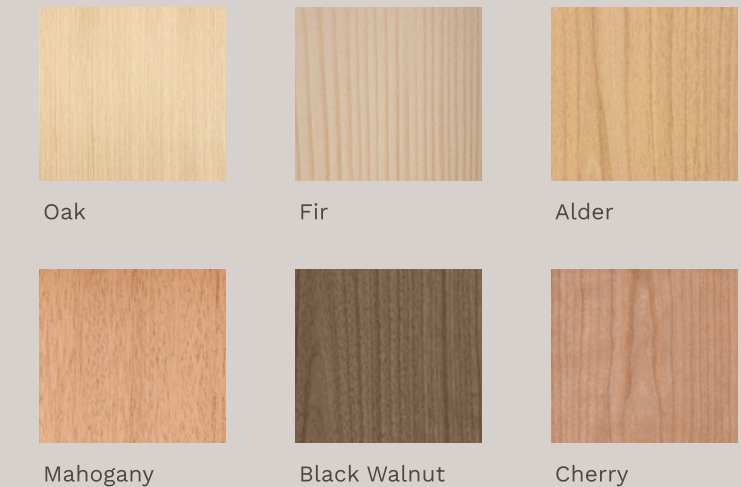

PREMIUM ORDER

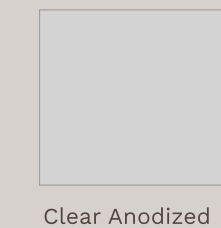

200+ RAL COLORS

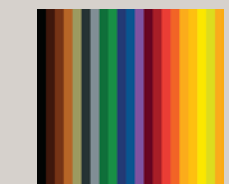

CUSTOM COLORS





CHAMBERLIN XL

With a newly designed frame featuring overlapping panels, the Chamberlin XL sets the standard for thermal efficiency and performance in sliding glass systems. Built to thrive in high-altitude and cold-weather conditions, it comes standard with triple-pane glass, delivering unmatched insulation and some of the best thermal ratings in the industry. This innovative design not only surpasses energy efficiency standards for even the harshest climates but also meets or exceeds building requirements across all 50 states. The Chamberlin XL reflects a commitment to exceptional performance, ensuring comfort, durability, and effortless beauty in every environment.

KEY FEATURES

- Design Pressure Rating, DP 50**
- California Title 24 compliant**
- Florida Building Code approved**
- Standard triple pane glass package**

◀ Cherry Hill, Colorado

DOOR CONFIGURATION

The Chamberlin XL Door is available with three different main door placements. You can have your main door located on the right or left sides or opt for butterfly with main doors on both ends of the system.

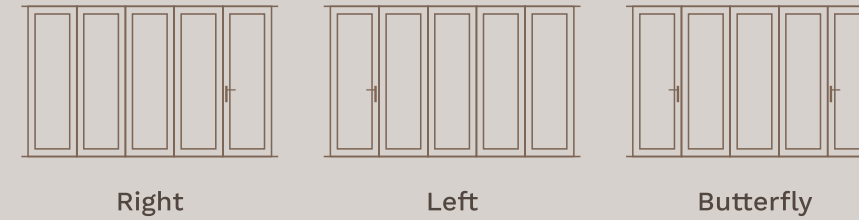

STANDARD COLORS

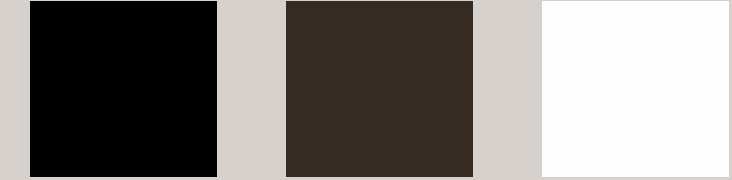

Textured Black Statuary Bronze Textured Apollo White

PREMIUM ORDER



Clear Anodized

DOOR SPECIFICATIONS

Max System Width	Unlimited
Max System Height	10 ft
Max Panel Width	40 in
Main Door One End	Yes
Main Door Both Ends (Butterfly)	Yes
U-Factor	0.25
SHGC	0.16
Florida Building Code	FL42297.1



COASTAL STORM DOOR

Expertly crafted for strength, security, and impact resistance, this door withstands nature's harshest elements. With a reinforced frame and six-point locking system, it achieves a DP 70 coastal rating for hurricane readiness against wind, rain, and debris. As the only independent "Slide-Pivot-Stack" door approved for High-Velocity Hurricane Zones under the Florida Building Code, it combines robust protection with elegant design, offering panoramic views on clear days and fortified safety during storms—perfect for modern homes and expansive properties.

KEY FEATURES

HVHZ Impact Glass Standard on all Coastal Systems

Design Pressure Rating, DP 70

Florida Building Code approved

Steel reinforcement

Overlapping T-sash

6-point locking system

◀ Palm Beach, Florida

DOOR CONFIGURATION

The Coastal Storm Door is available with three different main door placements. You can have your main door located on the right or left sides or opt for butterfly with main doors on both ends of the system.

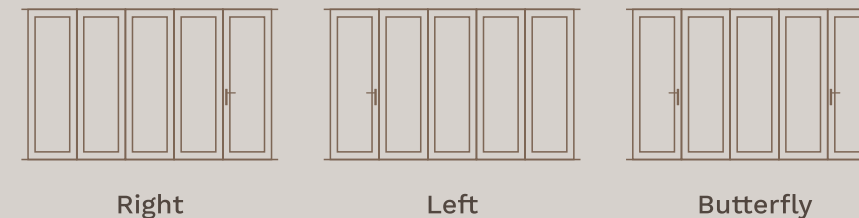

DOOR SPECIFICATIONS

Max System Width	48 ft
Max System Height	10 ft
Max Panel Width	40 in
Main Door One End	Yes
Main Door Both Ends (Butterfly)	Yes
U-Factor	0.4
SHGC	0.18
Florida Building Code	FL42307.1

STANDARD COLORS

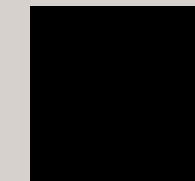

Textured Black



Statuary Bronze Textured

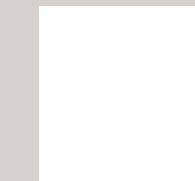

Apollo White

PREMIUM ORDER



Clear Anodized



ABSOLUTE VINYL DOOR

Designed to pair seamlessly with vinyl windows, this door combines the refined design of our Signature Aluminum Series with exceptional strength and durability. Its extruded vinyl over a reinforced aluminum frame ensures lasting performance and a sleek, minimalist aesthetic. For enhanced thermal efficiency, it is available with the Chamberlin foam-filled frame, making it one of our most energy-efficient solutions. Thoughtfully crafted to balance style and functionality, it ensures year-round comfort without compromising on modern design.

KEY FEATURES

Crafted with extruded vinyl over a reinforced aluminum frame

Concealed multi-point locking system for ease of operation and security

High thermal efficiency

Option to choose different interior and exterior finishes

Standard glass package: Solarban 70™/clear (other options available)

Design Pressure Rating, DP 30

◀ Atlanta, Georgia

DOOR CONFIGURATION

The Absolute Vinyl Door is available with two different main door placements. You can have your main door on the system's right or left sides.

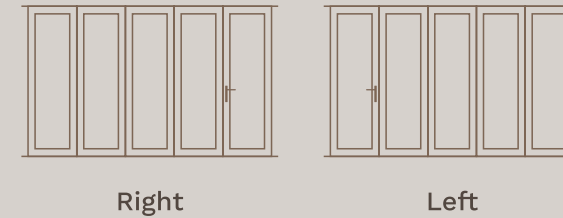

Right

Left

STANDARD COLORS



White

UPGRADED COLORS



Beige

LAMINATED COLORS

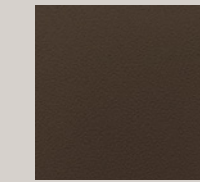

Bronze

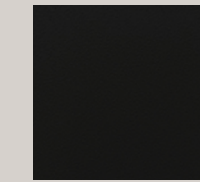

Black

DOOR SPECIFICATIONS

Max System Width	19.5 ft
Max System Height	8 ft
Max Panel Width	38 in
Main Door One End	Yes
Main Door Both Ends (Butterfly)	No
U-Factor	0.29
SHGC	0.17 - 0.18



CORNER DOOR

With its innovative post-less design, the Corner Door spans seamlessly across two walls, creating uninterrupted panoramic views and dissolving boundaries for an expansive, elegant aesthetic. Perfect for offices, classrooms, restaurants, or any space seeking to impress, it transforms interiors into open, dynamic environments, seamlessly connecting indoors and outdoors while redefining spatial flow and inspiration.

KEY FEATURES

- “Slide-Pivot-Stack” patented technology
- Two main doors on every system
- Postless view

DOOR SPECIFICATIONS

Max System Width	Match to System
Max System Height	10 ft
Max Panel Width	40 in
Main Door One End	Yes
Main Door Both End	Yes

◀ Austin, Texas ▶

FLAG DOOR

This innovative system combines a door and window at a post-less intersection, eliminating barriers for seamless spatial flow. Perfect for expanding kitchens into open-air dining areas, it invites natural light, fresh air, and uninterrupted views—elevating everyday moments into extraordinary experiences. Exclusively available with the Signature Aluminum Door and Pass-Through Window, it delivers design as limitless as the views it frames.

KEY FEATURES

- “Slide-Pivot-Stack” patented technology
- Door/window system combination
- Conversational pass-through

DOOR SPECIFICATIONS

Max System Width	Match to System
Max System Height	10 ft
Max Panel Width	40 in
Main Door One End	Yes

Lake Chelan, Washington, Parmenter Homes ▶





PASS-THROUGH WINDOWS

Sliding and stacking pass-through windows extend your space with uninterrupted sightlines and seamless transitions. Ideal for kitchens, dining areas, or poolside spaces, they pair with transom windows for a polished finish, blending function and style with precision craftsmanship.

KEY FEATURES

Available in both Aluminum & Vinyl

Interlocking tongue-n-groove for superior seal and security

Concealed multi-point locking system for ease of operation and security

WINDOW SPECIFICATIONS

Max System Width	Unlimited
Max System Height	8 ft
Max Panel Width	40 in
Swing Window One End	Yes
Swing Window Both Ends	No

◀ Chapel Hill, North Carolina

PICTURE WINDOWS

Designed to align with Panoramic Door systems, the matching picture window creates uninterrupted floor-to-ceiling sightlines. Perfect for stationary windows near or above your door, it enhances panoramic views and integrates seamlessly with our premium aluminum systems. This feature is not available for the Absolute Vinyl Door.

KEY FEATURES

Customizable colors

Available in Aluminum

Variety of glass options

Flexibility with sizing

WINDOW SPECIFICATIONS

Max System Width	Matched to System
Max System Height	8 ft

Saratoga, California ▶





RETRACTABLE SINGLE & DOUBLE SCREENS

Crafted from sheer yet durable fibers, the retractable screen delivers protection and elegance without obstructing views. Its innovative pleated design offers smooth, partial, or full closure, ensuring flexibility to suit your needs. Designed to cover up to 16 feet with a single screen—or 32 feet with a double—it seamlessly integrates into any space with a discreet profile that preserves the clean, modern aesthetic. Both practical and beautiful, it is an essential upgrade for enhancing your Panoramic Door system.

SCREEN CONFIGURATION

Our retractable screens are tested to make sure the only thing that gets in is the breeze—available in 16ft single screen and 32ft double screen. All screens are placed on the system's interior and slide on their own track.



16 ft Single Screen

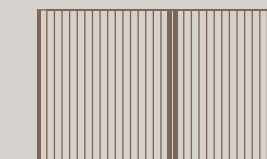

32 ft Double Screen

KEY FEATURES

Kevlar base for strength and performance

Painted to match your Panoramic Door

Durable pleated screen

Up to 16ft wide for a single screen and 32ft for a double screen

SCREEN SPECIFICATIONS

Max Screen Width	16 ft
Max Screen Height	10 ft
Max Double Screen Width	32 ft
Max Double Screen Height	10 ft
Visibility Through Screen	Yes

DOOR HANDLES

Explore our curated selection of carefully designed hardware to complement your Panoramic Door and elevate your personal style.

Estate

Estate handles provide a classic feel and a comfortable grip, in Black and Silver.



Black



Silver

Lakeview

Lakeview showcases a sleek square form, perfect for minimalism, available in Black, Silver and White.



Black



Silver



White

PASS-THROUGH WINDOW HANDLE

Sleek Panoramic Pass-Through Window Handles in Black, Silver, or White offer effortless operation, enhancing your window with style and security.



Black



Silver



White

MULTI-POINT LOCKING SYSTEM

3-Point Locking System

Security is important. That is why all our doors come with 3-point locking systems on all main doors. This ensures your doors are locked at the top, middle, and bottom.

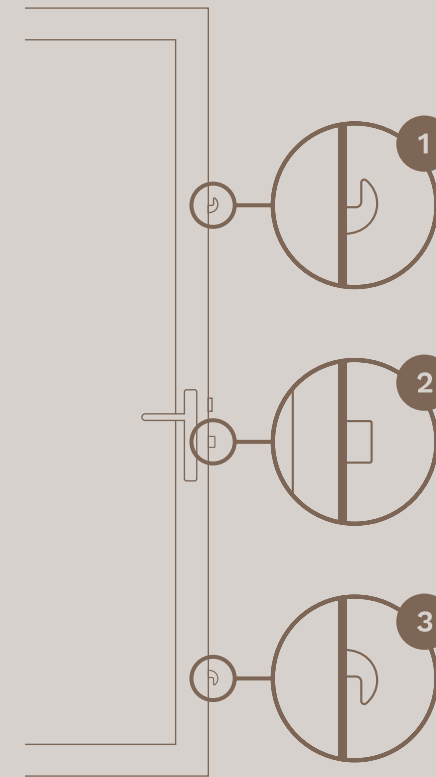

6-Point Locking System

For added security, our Coastal Storm Door boasts a 6-point lock system, including sturdy steel bolts and an extra locking hook for maximum strength in tough weather conditions.

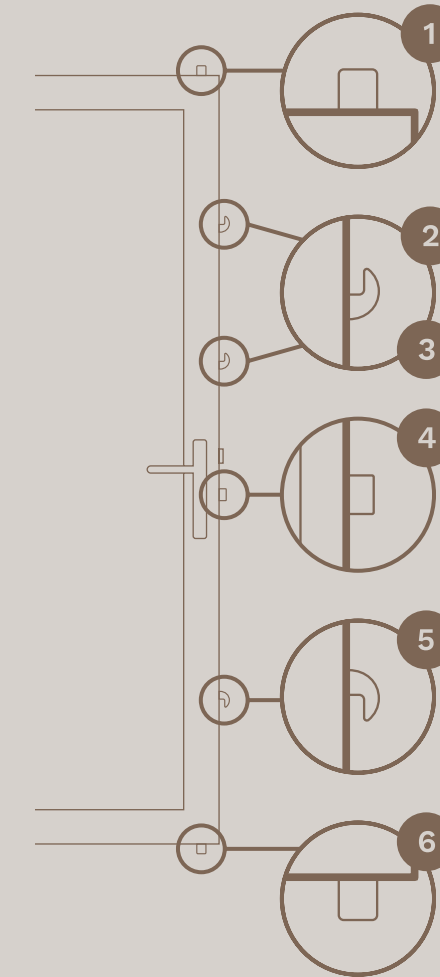

TRACKS

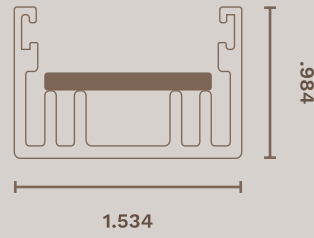

Screen Track

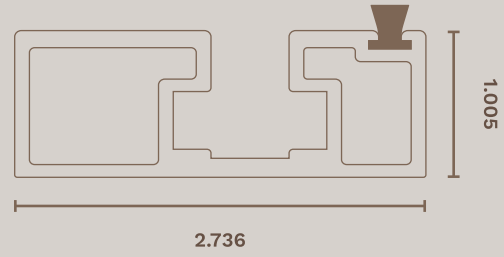

Flush Track

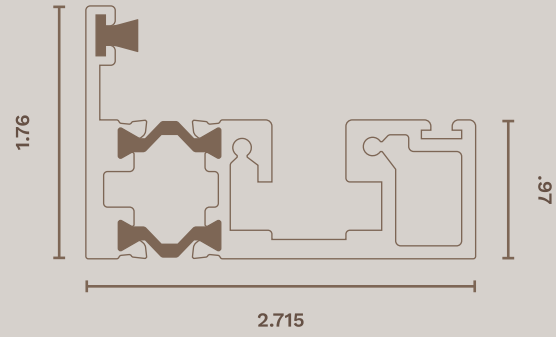

Upstand Track

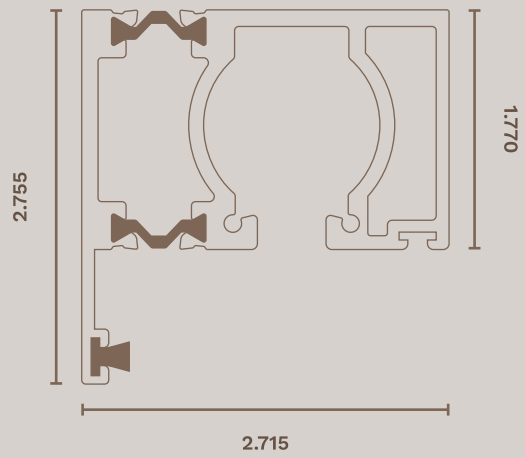

Top Track

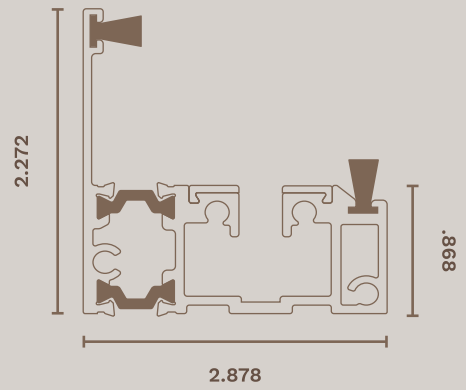

Coastal Storm Door Bottom Track

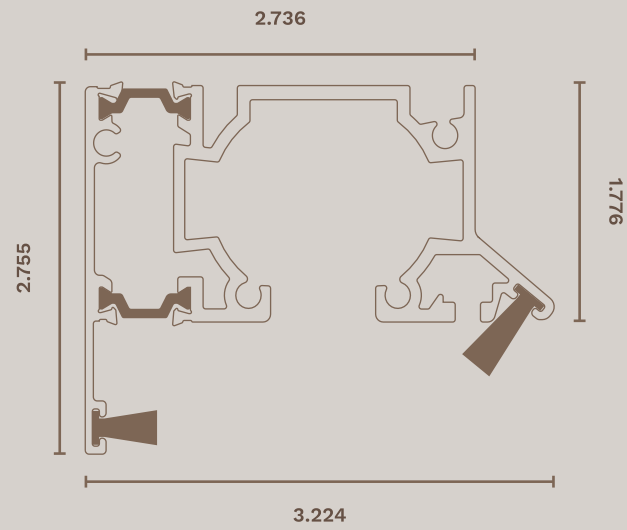

Coastal Storm Door Top Track

Track Placement

Depending on your design requirements, the bottom track can either be set on top of the subfloor or embedded into the floor.

Here are a few of the most common placements for both the upstand track and the flush track.

Please consult with your contractor or sales representative as to the suitability of both the track and the placement of the bottom track.

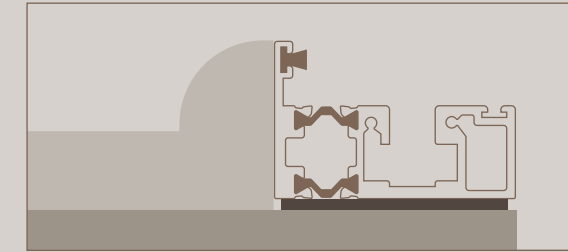

Upstand track on subfloor

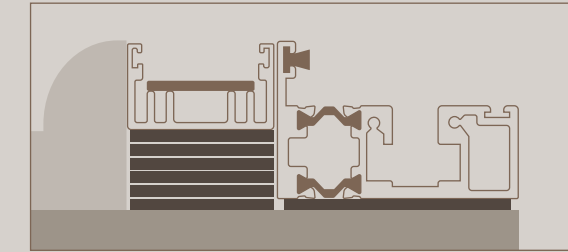

Upstand track and screen on subfloor

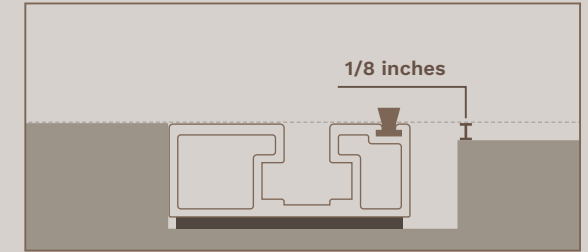

Flush track inset in subfloor

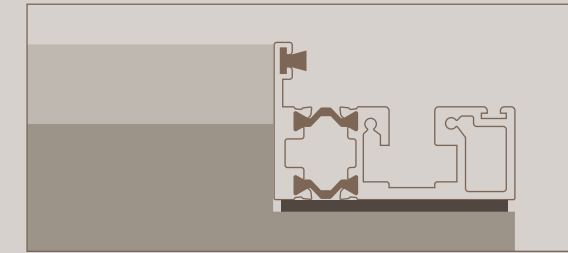

Upstand track on cut subfloor

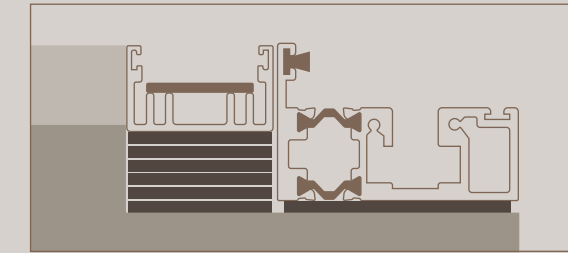

Upstand and screen track on cut subfloor

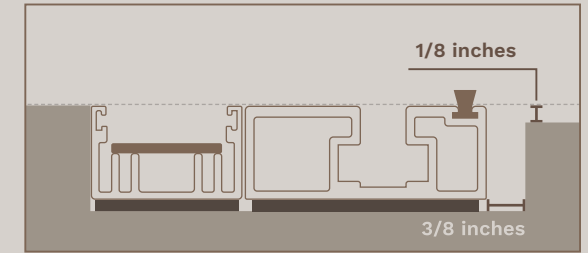

Flush and screen track inset in subfloor

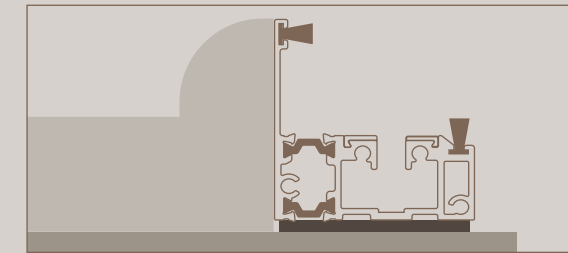

Coastal Storm Door Bottom track on subfloor

GLASS TREATMENT OPTIONS

Our glass at Panoramic Doors™ is thermally broken for superior energy efficiency, reducing heat transfer and ensuring optimal comfort year-round. Low-E coatings provide exceptional insulation and UV protection, while Argon gas-filled panels and breather tubes for higher-altitude installations enhance performance in any environment.

Customizable options include obscure glass for privacy, Turtle Glass to reduce glare in coastal areas, and the flexibility to treat select panels or the entire system to meet your needs. Panoramic Doors™ delivers innovative, energy-smart glass solutions designed to complement your lifestyle.

GRID OPTIONS

Looking to add Grids to your Panoramic Door system? We have options to meet your tastes.



Exterior Grid

SDL - Simulated Divided Lights

Exterior grid system flush off the sash



Interior Grid

GBG - Grids Between Glass

Interior grid system between glass panels, offering a variety of design options.

GLASS TREATMENTS



Obscure

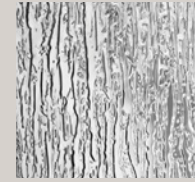

Rain Glass



Satin Etch



Turtle Glass

GLASS TINTS



100+ Tint Colors

RESOURCE GUIDE & CONTACT INFORMATION

With Panoramic Doors™, you're buying factory-direct—no middlemen, no unnecessary markups. This means you get premium-quality doors at unbeatable prices, straight from the source.

Showrooms

- | | | |
|-------------|-----------------|----------------|
| Atlanta | Fort Lauderdale | Salt Lake City |
| Austin | Houston | San Diego |
| Burlingame | Kansas City | Scottsdale |
| Chapel Hill | Los Angeles | Seattle |
| Dallas | Orange County | Tampa |
| Denver | Orlando | |



Scan QR Code to see our **Showroom Location Map** on our website

Customer Sales

For quotes, product inquiries, and purchasing support, our customer sales team is available via both email and phone.

Days: Monday - Saturday

Time: 8 am - 7 pm Central

Phone: 817-952-3500

Email: sales@panoramicdoors.com



Scan QR Code to **request a quote** on our website

Service + Technical Support

For questions regarding parts, product operation, or repair.

Days: Monday - Friday

Time: 8 am - 5 pm Central

Phone: 760-616-5018

Email: service@panoramicdoors.com



Scan QR Code to visit our **Installation Resources** page on our website

CERTIFICATIONS & ASSOCIATIONS



California Title 24 Compliant



Florida Building Code Compliant



Texas Department of Insurance



Miami-Dade County Approved

Seamless Views, Infinite Possibilities

Panoramic Doors™ innovative Slide-Pivot-Stack
system transforms the way you experience space.

